

THE

General Radio

EXPERIMENTER



VOLUME XX No. 12

MAY, 1946

Copyright, 1946, General Radio Company, Cambridge, Mass., U. S. A.

ELECTRICAL MEASUREMENTS AND THEIR INDUSTRIAL APPLICATIONS

<i>Also</i>	
IN THIS ISSUE	
	<i>Page</i>
D AND Q	5
NEW ADDRESS FOR WEST-COAST OFFICE ..	8

V-5 SERIES VARIACS — NEW, IMPROVED MODELS REPLACE 200-C SERIES

● FOR MANY YEARS the 200-C Variac has been our most popular single instrument. We might, perhaps, have chosen to let well enough alone and continued 200-C sales indefinitely. Yet, inevitably,

such a course collides with the hard fact that failure to progress is to retrogress.

Mere change, however, is not progress. In supplanting the 200-C with the V-5 we have made every effort to incorporate features that are truly improvements. Careful consideration has been given to each factor, including greater convenience and utility, reliability, improved appearance, and increased value.

For your convenience the V-5 has the new General Radio Unit Brush,

FIGURE 1. The old and the new. At the right is shown the new TYPE V-5MT, at the left the old TYPE 200-CM.



TET LABS, INC in the GenRad tradition

534 Main Street, Westbury, NY 11590

www.ietslabs.com

TEL: (516) 334-5959 • (800) 899-8438 • FAX: (516) 334-5988



FIGURE 2. "The new General Radio unit brush . . . can be changed without tools."

which can be changed (Figure 2) without tools. The V-5 Brush has a further advantage in that its low sprung weight reduces hammering and arcing under vibration conditions, injurious to both brush and winding, and it is designed to prevent contact of the brush holder with windings and consequent short-circuit damage. Proper brush pressure is assured by the use of an accurate coil spring, which in turn is electrically shunted so that the spring is not subjected to load current. Brush travel is limited by a resilient stop.

No longer is it necessary to take practically the whole moving assembly apart to reverse a shaft in changing from panel to table mounting, or vice versa. A single screw (Figure 3) loosens the shaft for removal or tightens it in assembly. Brush adjustment and the resilient stop setting are unaffected by shaft reversal.

FIGURE 3. "A single screw loosens the shaft for removal or tightens it in assembly."

Variacs have to be carried, and knobs are poor and unreliable handles, relying, as they do, on set screws. Figure 4 shows the V-5 cord with molded-on plug which, wound about the Variac and plugged into the Variac outlet, serves as an excellent carrying strap.

Rubber feet, that squeeze back into their sockets for panel mounting, make V-5 Variacs considerate of your bench, table, or desk, and provide sufficient friction to prevent slipping even on smooth surfaces. Rounded contours, devoid of sharp or irregular projections, still further protect against damage to adjacent objects (including hands and feet) in the inevitable bumps and drops that occur in the life of an instrument.

Dials with BIG calibration figures and additional scale points make V-5 Variacs easy to read and to reset. Clockwise rotation to increase output is the rule.

Terminals have both solder and screw connection facilities, are easy to get at, and logically arranged. Barriers reduce the hazard of short-circuits from loose strands. A circuit diagram, integral with the terminal strip, identifies each lead and indicates normal voltages (not turns, as heretofore) between leads as a wiring aid. Extra





terminals (6 and 7) greatly extend the usefulness of the V-5 Series Variacs when used with supplementary transformers. The terminal strip itself is a high-impact-strength molding, protected by a metal, fiber-lined cover to reduce further the possibility of breakage. If, however, you are ingenious enough to break it, the only tool required for replacement is a screw driver.

Next to a zipper, the V-5 case and terminal cover assembly method is the fastest. Two screws only are required for the assembly of the two pieces to the base. A cover band, carrying integral rivets, cooperates with the screws to form a secure yet rapid assembly. Type numbers distinguishing cased and uncased models are automatically formed by registering tabs on the parts.

A new, heavy-duty switch breaks both sides of the line in mounted V-5 models. Provision is made for polarity indication for use with grounded loads, which, while seldom recommended, are sometimes required.

General Radio Company has never featured appearance for appearance's sake. Yet V-5 Variacs have a distinctly modern look, naturally and functionally derived. Curves instead of angles result from the maintenance of fixed clearances with a minimum of enclosing material. The top "band" is used to position the perforated cover side when it is welded to the top ring. The bottom "band" which forms the other termination of the cylindrical portion of the enclosure carries fastening rivets as previously explained. Both are functional. The flush dial is a perfectly logical method of conserving space and material, as it is eminently suitable to form a portion of the enclosure. The perforations were deliberately chosen to accent the cylindrical nature of the design. Perforations



FIGURE 4. "... the V-5 cord with molded-on plug which, wound about the Variac and plugged into the Variac outlet, serves as an excellent carrying strap."

were required in any event; better attractive than not.

The finish selected for V-5 Variacs is an exceptionally durable matte baking lacquer. Its lack of high lights prevents distraction of attention and preserves the unity of the basic design. The use of aluminum for structural parts with attendant corrosion resistance is further enhanced by this wear-resistant and attractive covering.

Last but not least, don't overlook the fact that V-5 Variacs deliver 25 per cent more KVA per pound than equivalent 200-C models. Grain-oriented strip cores permit reductions in both iron and copper for comparable ratings. Aluminum instead of zinc and steel in structural parts furthers this weight reduction.

— GILBERT SMILEY





SPECIFICATIONS

Note: Models are designated by type number. The basic VARIACS, V-5 (for 115-volt input) and V-5H (for 230-volt input), are supplied with terminal strip, but without case, terminal box, switch, convenience outlet, and cord. Models V-5M and V-5HM include the case. Models V-5MT and V-5HMT are complete mounted

models with case, terminal box, switch, cord, and outlet.

Dials: Dials are engraved for overvoltage connection (135 or 270 volts maximum). Special dials are available for 115- and 230-volt maximum output. Dial is reversible, one side for table mounting, the other for panel.

Type	V-5	V-5M	V-5MT	V-5H	V-5HM	V-5HMT
Load Rating (KVA)	.862	.862	.862	.575	.575	.575
Input Voltage	115	115	115	230 or 115	230 or 115	230 or 115
Output Voltage (Zero to)	135 115	135 115	135 115	270 230	270 230	270 230
Rated Current (Amperes)	5	5	5	2 1*	2 1*	2 1*
Maximum Current (Amperes)	7.5	7.5	7.5	2.5	2.5	2.5
No-Load Loss — 60 \sim (Watts)	9	9	9	9	9	9
Driving Torque (Inch — Ounces)	30-50	30-50	30-50	30-50	30-50	30-50
Overall Height for Table Mounting (Inches)	5	5	5	5	5	5
Maximum Panel Thickness (Inches)	$\frac{3}{8}$	$\frac{3}{8}$	$\frac{3}{8}$	$\frac{3}{8}$	$\frac{3}{8}$	$\frac{3}{8}$
Depth behind Panel (Inches)	$3\frac{21}{64}$	$3\frac{21}{64}$	$3\frac{21}{64}$	$3\frac{21}{64}$	$3\frac{21}{64}$	$3\frac{21}{64}$
Diameter of Variac Cylinder (Inches)	$4\frac{13}{16}$	$4\frac{13}{16}$	$4\frac{13}{16}$	$4\frac{13}{16}$	$4\frac{13}{16}$	$4\frac{13}{16}$
Add for Terminals (Inches)	$\frac{9}{16}$	$\frac{9}{16}$	$1\frac{15}{16}$	$\frac{9}{16}$	$\frac{9}{16}$	$1\frac{15}{16}$
Net Weight (Pounds)	$6\frac{3}{4}$	7	$7\frac{5}{8}$	$6\frac{1}{2}$	$6\frac{3}{4}$	$7\frac{3}{8}$
Code Word	COBRA	COPAL	CORAL	CULPA	CUMIN	CUPID
Price	\$16.50	\$17.50	\$20.00	\$21.50	\$22.50	\$25.00

*With 115-volt input applied across half the winding.

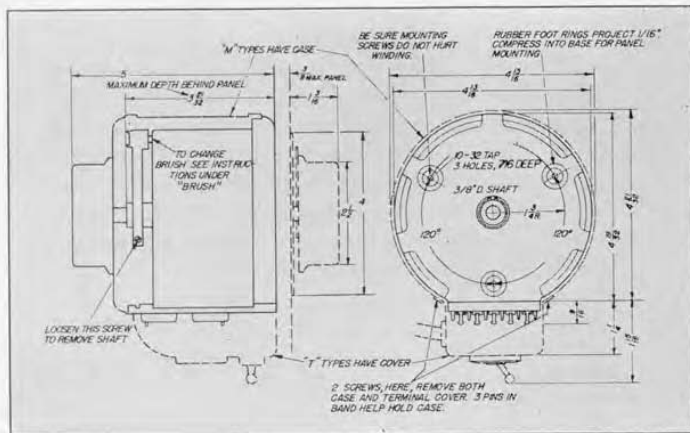

FIGURE 5. Universal dimension drawing for the V-5 series of Variacs. The basic V-5 Variac is shown in full lines. The case (M) and the terminal-box cover (T) are shown dotted. The knob and dial in panel mounting position are also shown dotted.





D AND Q

● **THE POWER LOSSES** in both capacitors and inductors can be expressed in several different ways. In a perfect reactor the current either leads or lags the voltage by exactly 90° as shown in Figure 1. When power losses occur, the phase angle θ becomes less than 90° by an angle δ called the loss angle or phase defect angle, as shown in Figure 2. The power loss W is a direct function of this loss angle:

$$W = EI \cos \theta = EI \sin \delta \quad (1)$$

where the trigonometric functions are defined as the power factor.

The reactor can be represented either as a parallel or series circuit,¹ as shown in Figures 3 and 4. For these circuits, the power loss is

$$W = \frac{E^2}{R_p} = E^2 G = I^2 R_s \quad (2)$$

The ratio of parallel reactance and parallel resistance is called the dissipation factor D , while its reciprocal is called the storage factor Q .

$$D = \frac{1}{Q} = \frac{X_p}{R_p} = \frac{G}{B} = \frac{R_s}{X_s} \quad (3)$$

Combining Equations (2) and (3)

$$W = \frac{E^2 D}{X_p} = \frac{E^2}{Q X_p} = I^2 D X_s = \frac{I^2 X_s}{Q} \quad (4)$$

¹ Tuttle, W. N., "The Series and Parallel Components of Impedance," *General Radio Experimenter*, XX, 8, January, 1946.

FIGURE 1 (left). Relation between current and voltage for a perfect reactor. Phase angle θ is 90° . FIGURE 2 (right). Relation between current and voltage for a reactor having losses. Phase angle θ differs from 90° by loss angle.

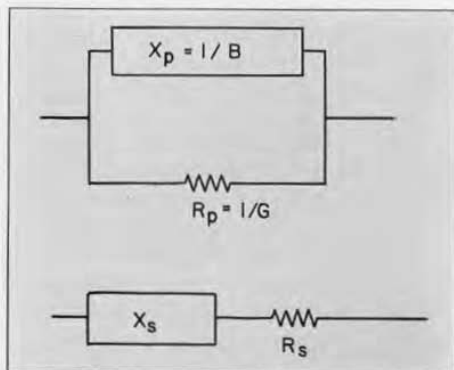
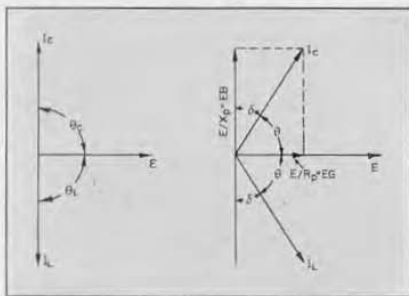

FIGURE 3 (above). Parallel components of a reactor.

FIGURE 4 (below). Series components of a reactor.

The names of these factors are appropriate, for dissipation factor D is proportional to the power dissipated in the resistive elements, and storage factor Q is proportional to the power stored in the reactive elements. The relation of these factors to the phase and loss angles as shown in Figure 2 is

$$D = \frac{1}{Q} = \cot \theta = \tan \delta \quad (5)$$

Dissipation factor and power factor differ by less than 1% when their values are less than 0.15.

Dissipation factor and storage factor are used as figures of merit, or quality factors, for capacitors and inductors. It has become customary to use dissipation factor D for capacitors and storage factor Q for inductors. There are, however, many reasons for using dissipation factor exclusively. In the first place, any power loss is a defect, a departure from perfection, and the factor that measures it should vary directly with it and go to zero for zero loss. Dissipation factor meets this requirement and storage factor does not. Values for several types of capacitors are given in Table I.

TABLE I

Capacitors	D	Q
Paper, Ordinary	0.02	50
Paper, Quality	0.005	200
Mica, Ordinary	0.002	500
Mica, Quality	0.0005	2000
Polystyrene	0.0002	5000

It is sometimes urged that dissipation factor is awkward because it is a decimal, with several ciphers before the significant figure. To remedy this, dissipation factor has been expressed in per cent, as is customary for power factor when used for power transmission. This has led to endless confusion when it becomes necessary to state the accuracy of its measurement also in per cent. For this reason, it is expressed as a ratio in all ASTM specifications and in all General Radio publications. There is only a slight gain in the number of figures required if storage factor Q is used instead, as is shown in Table I, and the ability to show accuracy by the number of significant figures is impaired.

In the second place, whenever there is more than one source of loss in a reactor, the dissipation factors representing such losses add directly to give the total dissipation factor. Multiple storage factors can be added only by taking the reciprocal of the sum of their reciprocals, in other words by first calculating dissipation factor. A good example of multiple dissipation factors is offered by a capacitor with a solid

dielectric,² such as mica. Over a wide frequency range there are three kinds of losses, as shown in Figure 5. At low frequencies interfacial polarization produces a dissipation factor D_i , which decreases with increasing frequency in such manner that it results in a straight line with a slope less than 45° on a log-log plot of dissipation factor against frequency. Such a law would produce a very low dissipation factor at high frequencies. There is in addition a residual polarization, whose origin is not understood, which produces a minimum dissipation factor D_r , that is constant with frequency. At high frequencies ohmic resistance in the leads to the capacitor becomes an important source of loss, both because the reactance decreases with increasing frequency and because skin effect in the leads increases their resistance as the square root of the frequency. Hence, dissipation factor D_s from this source increases as the $3/2$ power of frequency. Total dissipation factor is the sum of the three separate dissipation factors. Obviously, storage factor is useless in such a summation.

Storage factor Q has been used for inductors for a long time in connection with tuned circuits. In a tuned circuit in which a voltage e is introduced either through a series resistance as

FIGURE 5. Component dissipation factors of a mica capacitor; D_i from interfacial polarization, D_r from residual polarization, and D_s from series resistance.

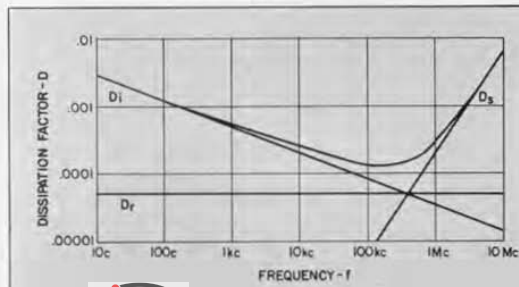
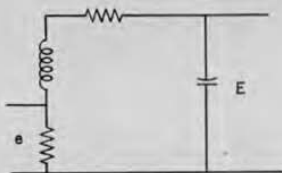

FIGURE 6. Circuit for measuring step-up voltage ratio.





shown in Figure 6, or inductively, the ratio of the voltage developed across the tuning capacitor to the input voltage is the storage factor Q of the circuit.

$$\frac{E}{e} = Q = \frac{\omega L}{R} = \frac{1}{R\omega C} \quad (6)$$

If an air capacitor or a mica capacitor is used, the losses of the inductor are usually so much greater than those of the capacitor that it has become common practice to consider that this voltage step-up is the storage factor Q of the inductor. But even here there may be multiple losses. With care it is possible to design an air core inductor using insulated stranded wire (litzendraht) having a dissipation factor of 0.002 ($Q = 500$). A poor mica capacitor could easily have a dissipation factor of 0.001 ($Q = 1000$). Here is a 50% error if the voltage step-up is used. If both losses are considered, it is much faster to note that the total dissipation factor is 0.003 than to add the reciprocals of 500 and 1000 which, when it is done, amounts to first calculating dissipation factor.

Inductors furnish just as good an example of multiple dissipation factors as capacitors. In an iron-core coil there are three sources of loss³, as shown in Figure 7. At low frequencies, the dis-

³McElroy, P. K., and Field, R. F., "How Good is an Iron-Cored Coil?", *General Radio Experimenter*, XVI, 10, March, 1942.

FIGURE 7. Component dissipation factors of an iron-cored coil; D_c from ohmic resistance, D_h from hysteresis, and D_e from eddy currents.

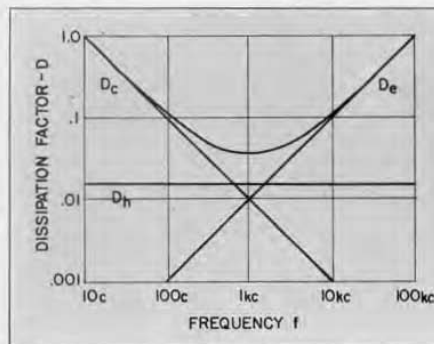

sipation factor D_c produced by the ohmic resistance of the inductor varies inversely with frequency and is therefore a straight line sloping down at 45° on a log-log plot of dissipation factor against frequency. Hysteresis losses in the iron core provide a dissipation factor D_h which is constant with frequency and whose magnitude increases with flux density. Eddy current losses in the iron laminations increase with frequency and produce a dissipation factor D_e which increases directly with frequency. The total dissipation factor is the sum of the three separate dissipation factors. As noted under capacitors, it would only complicate matters to try to use storage factor Q .

Air-core inductors used near their resonant frequencies offer a different set of three losses. Ohmic resistance furnishes a dissipation factor D_c varying inversely with frequency as shown in Figure 8. There are eddy current losses in the copper winding which behave in the same manner as eddy current losses in iron and give a dissipation factor D_e which increases directly with frequency. Finally the distributed capacitance of the inductor has a dissipation factor D_0 of its own and determines, with the inductance of the coil, a natural frequency f_0 . The dissipation factor D_f

FIGURE 8. Component dissipation factors of an air-cored coil; D_c from ohmic resistance, D_e from eddy currents, and D_f from distributed capacitance.

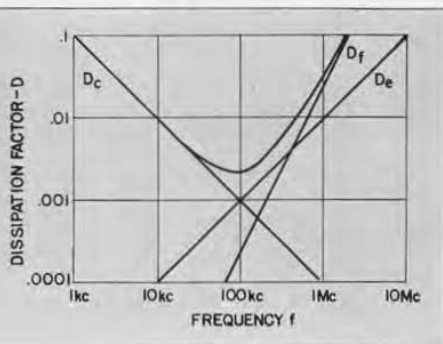



which this capacitance produces in the coil varies with the square of the frequency, having, of course, the value D_0 at f_0 . Again this total dissipation factor is the sum of the three separate dissipation factors.

An even more complicated case is a multiple layer toroid with a low permeability dust core for use at high frequencies. There are five sources of loss, ohmic resistance, eddy currents in both iron and copper, hysteresis losses

in the iron, and dielectric losses in the distributed capacitance.

It thus appears that in both the analysis and the synthesis of losses in capacitors and inductors, dissipation factor best expresses their losses. Since both capacitors and inductors are now used over very wide ranges of frequency, it is logical to use for all other calculations the factor in terms of which the losses are best expressed, namely dissipation factor D .

— ROBERT F. FIELD

NEW ADDRESS FOR WEST COAST OFFICE

● **IN ORDER** to take care of the increasing activity of our west-coast office, we are moving to larger quarters at 950 North Highland Avenue, Los Angeles 38, California, about two blocks west of our former location. The telephone number is Hollywood 6201.

The increased space and better facilities at the new address will enable Mr. Frederick Ireland, the engineer in charge, and his staff to handle the requirements of our west-coast customers with the same efficient service as in the past.

GENERAL RADIO COMPANY

275 MASSACHUSETTS AVENUE
CAMBRIDGE 39 MASSACHUSETTS
TELEPHONE: TROWBRIDGE 4400

BRANCH ENGINEERING OFFICES

NEW YORK 6, NEW YORK
90 WEST STREET
TEL.—WORTH 2-5837



LOS ANGELES 38, CALIFORNIA
950 NORTH HIGHLAND AVENUE
TEL.—HOLLYWOOD 6201

CHICAGO 5, ILLINOIS
920 SOUTH MICHIGAN AVENUE
TEL.—WABASH 3825



IET LABS, INC in the GenRad tradition

534 Main Street, Westbury, NY 11590

www.ietlabs.com

TEL: (516) 334-5959 • (800) 899-8438 • FAX: (516) 334-5988